

Opportunities

for Annual Assembly Support

#aapmr22

**BALTIMORE, MD & VIRTUAL
OCTOBER 20-23, 2022**

2792
ATTENDEES

90%
OF ATTENDEES
ARE AAPM&R
MEMBERS

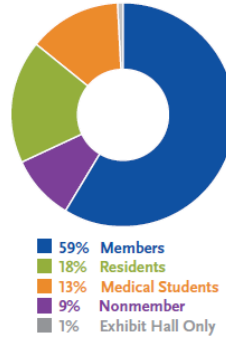

Registration numbers based on #AAPMR19 (Live Meeting)

23% HOLD A SUBSPECIALTY CERTIFICATION

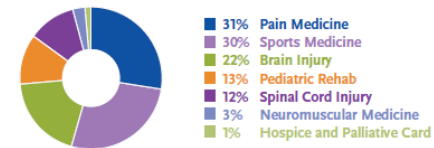

PRIMARY PRACTICE SETTING



94%

OF ATTENDEES
WOULD RECOMMEND
THE ANNUAL ASSEMBLY
TO THEIR PEERS

498

RESIDENTS ATTENDED
THE ASSEMBLY

96%

OF ATTENDEES
VISIT THE
PM&R PAVILION

**THE BEST IN
EDUCATION**

75+
EDUCATIONAL
SESSIONS

14
3-HOUR, HANDS-ON
SKILLS LABS

4
PLENARY
SESSIONS

12
CLINICAL AND
PRACTICE THEMES

**All data taken from the Annual Assembly Attendee Demographics Report, Exhibitor Survey and Attendee Survey.*

#aapmr22

**BALTIMORE, MD & VIRTUAL
OCTOBER 20-23, 2022**

#AAPMR22 Important Locations

- Convention Center: Baltimore Convention Center, One West Pratt Street, Baltimore, MD
- Date of Meeting: October 20-23, 2022
- Exhibit Hall: Baltimore CC – Halls E-G, Level 1
- Registration: Level 3
- Job and Fellowship Fair: Hall D, Level 1
- Meeting Rooms: Levels 3 and 4
- General Session: Ballroom, Level 4
- Headquarter Hotel: Hilton Hotel

#aapmr22

**BALTIMORE, MD & VIRTUAL
OCTOBER 20-23, 2022**

Reach All Registrants
Before and During #AAPMR22

#aapmr22

**BALTIMORE, MD & VIRTUAL
OCTOBER 20-23, 2022**

Reach Registrants Through Emails

Registration Confirmation Email

- Sponsor's logo will appear on the confirmation email that is sent once an attendee registers.
- Logo is linkable to your website.

Opportunity Cost: \$10,000

Know Before You Go Email

- Sponsor Logo or banner ad will appear on the Know Before You Go email sent to all pre-registered attendees prior to #AAPMR22.
- This email illustrates meeting highlights (i.e., activities, destinations and logistical information).
- Sponsor logo can link to the sponsor's website.

Opportunity Cost: \$10,000

#aapmr22

**BALTIMORE, MD & VIRTUAL
OCTOBER 20-23, 2022**

Mobile App

As the sponsor of the mobile app:

- Corporate logo on splash page
- On the rotating banner
- And on prominent signage
- Includes one push notification directing attendees to your booth or other activity each day.
- Only one sponsorship is available

Opportunity Cost: \$30,000

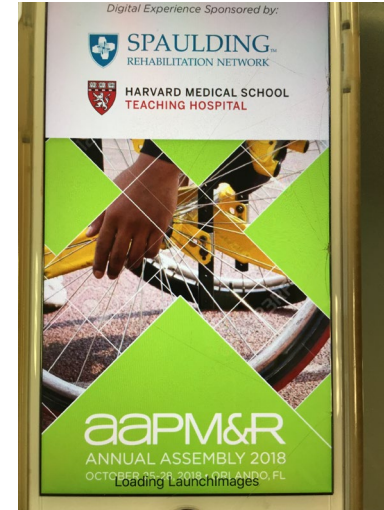

85% of Attendees download the mobile app.

#aapmr22

**BALTIMORE, MD & VIRTUAL
OCTOBER 20-23, 2022**

Headquarter Hotel

The Hilton

#aapmr22

**BALTIMORE, MD & VIRTUAL
OCTOBER 20-23, 2022**

Headquarter Hotel – The Hilton

Hotel Room Drop

- Have your flyer delivered to attendees staying at the HQ hotel

Opportunity Cost: \$8,000

Hotel Key Cards

- To all registered attendees at the hotel
- Logo on Key Card

Opportunity Cost: \$35,000

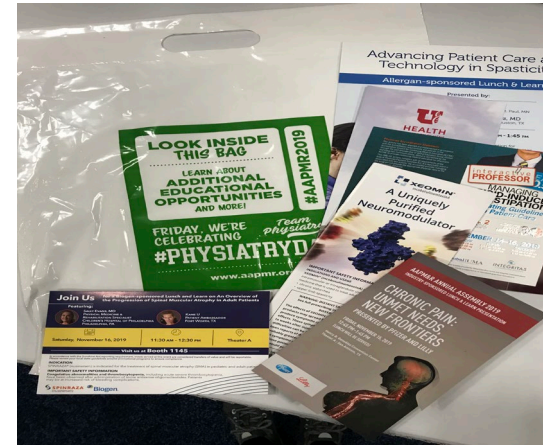

#aapmr22

**BALTIMORE, MD & VIRTUAL
OCTOBER 20-23, 2022**

Headquarter Hotel – The Hilton

Hotel Elevator Clings

- 6 elevators to and from the guest rooms
- Artwork specs: 41 1/2" x 80 3/4"

Opportunity Cost: \$45,000

Hotel Column Wraps

- 2 columns in the hotel lobby
- Double-sided 2 panels
- 4' x 6'

Opportunity Cost: \$30,000

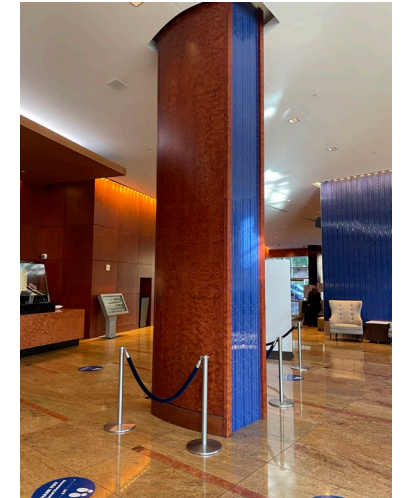
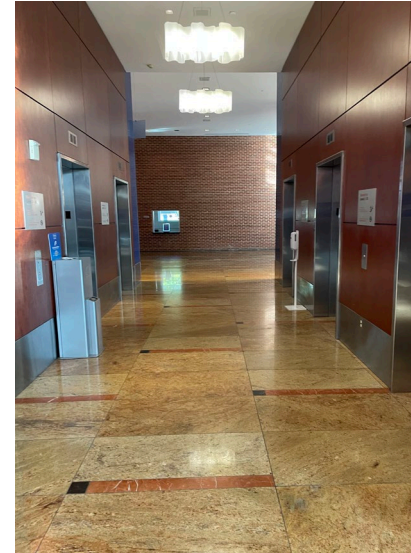

#aapmr22

**BALTIMORE, MD & VIRTUAL
OCTOBER 20-23, 2022**

Brand the path from the Hilton to the Convention Center

The Hilton Hotel is next door to the Baltimore Convention Center. It is connected via a sky bridge (see picture). Attendees will travel this path on multiple occasions. Sky bridge can be branded inside and out.

- Outside Only
Includes 16, 3 x 8 panels
Opportunity Cost: \$45,000
- Inside Only
Includes 6 window clings, 15, 3 x 3 footprints and 6-meter boards (double sided) – all showing the path
Opportunity Cost: \$30,000



Sky bridge



#aapmr22

**BALTIMORE, MD & VIRTUAL
OCTOBER 20-23, 2022**

Branding Opportunities

#aapmr22

**BALTIMORE, MD & VIRTUAL
OCTOBER 20-23, 2022**

Get Your Brand On All Attendees

Attendee Registration Bag

- Corporate Logo(s) on each bag plus recognition in *Official Program*, Mobile App, and AAPM&R Signage

Opportunity Cost: \$35,000

Lanyards

- Corporate logo on each lanyard given to all attendees, plus recognition in *Official Program* and Mobile App

Opportunity Cost: \$30,000



#aapmr22

**BALTIMORE, MD & VIRTUAL
OCTOBER 20-23, 2022**

Banners

Banner opportunities in strategic locations for multiple views

- **Banner 1:** Located at top of escalator at the entrance to the Convention Center. Viewed by attendees as the enter the CC or when coming from exhibit hall to sessions/registration/general session
- **Banner 2:** Located in Registration and will be viewed as attendees leave the CC or go down to the Exhibit Hall
 - ✓ Size of each: 30' x 8'

Opportunity Cost: \$30,000 each opportunity

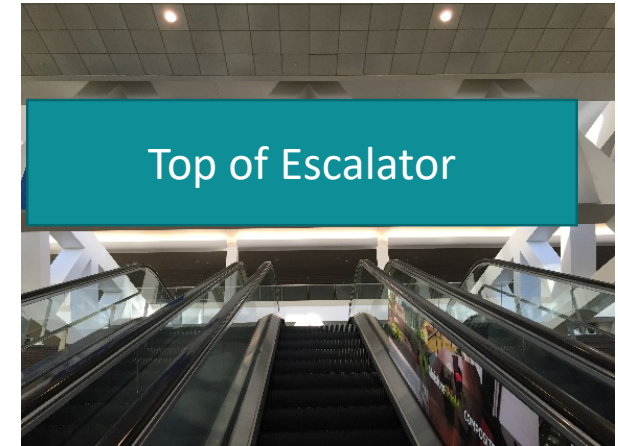

#aapmr22

**BALTIMORE, MD & VIRTUAL
OCTOBER 20-23, 2022**

Branding Opportunity

Aisle Signs

Help attendees as they navigate the vast exhibit hall

Your logo / message on all aisle signs.
Size approx: 2'x4'

Opportunity Cost: \$20,000

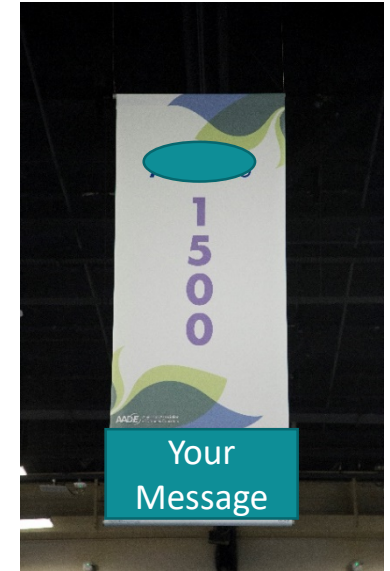
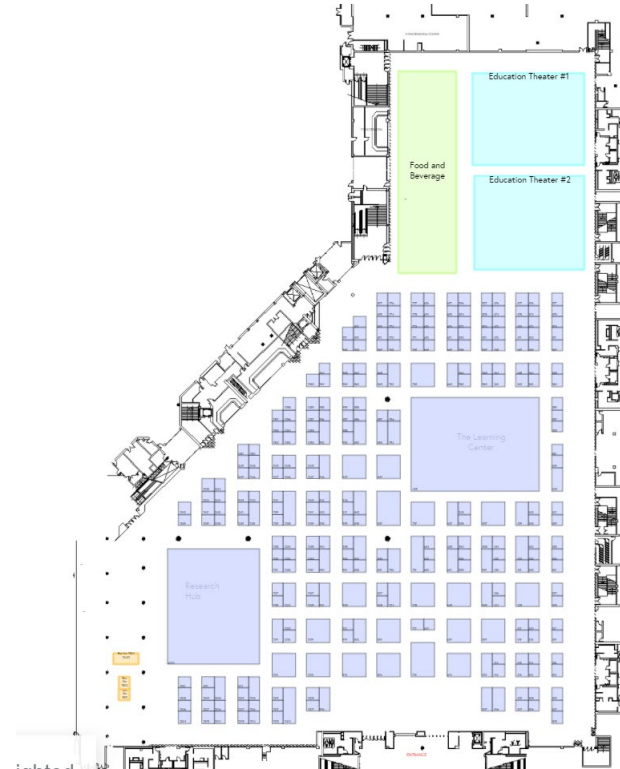

#aapmr22

**BALTIMORE, MD & VIRTUAL
OCTOBER 20-23, 2022**

Schedule of Events



New for 2022, sponsor the digital Schedule of Events Wall.

- Located in a high traffic area near registration
- 4 monitors
- 2 monitors with the schedule and other important AAPM&R information
- 2 monitors for your use (product information, booth number, education schedule and information)
- Information is up-to-date and can change daily
- Your logo on the structure

Opportunity Cost: \$26,500

#aapmr22

**BALTIMORE, MD & VIRTUAL
OCTOBER 20-23, 2022**

Own the Entrance of the Exhibit Hall

The Pratt Street entrance to the exhibit hall is the only entrance into the exhibit hall where attendees will access the Job and Fellowship Fair, Research Hub, lunch, and, of course, exhibits! Welcome attendees to the exhibit hall with 2 column wraps and a carpet logo as you enter the hall:

- 8' x 5' carpet logo, \$10,000
- 3-sided Kiosk wrapping the column, \$10,000, 2 for \$18,500

Opportunity Cost: \$28,500

*Add footprints to your booth
Opportunity Cost: Set of 12, \$10,000

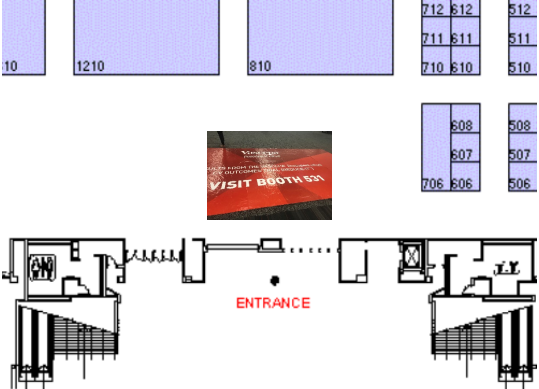

#aapmr22

**BALTIMORE, MD & VIRTUAL
OCTOBER 20-23, 2022**

Meet Up Zone

New in 2022 Meet Up Opportunities! A place where attendees can gather while social distancing. Located near Registration and Session Rooms on the 3rd level. Attendees will walk by and make use of this area (coffee stand nearby)

Includes:

- Clings on windows and railings (10)
- 2 Meter boards
- 6 Table logos
- Messaging in mobile app and the Know Before you Go email

Opportunity Cost: \$15,000

Add the Banner Above: \$18,500 (approx. 15'x 8')

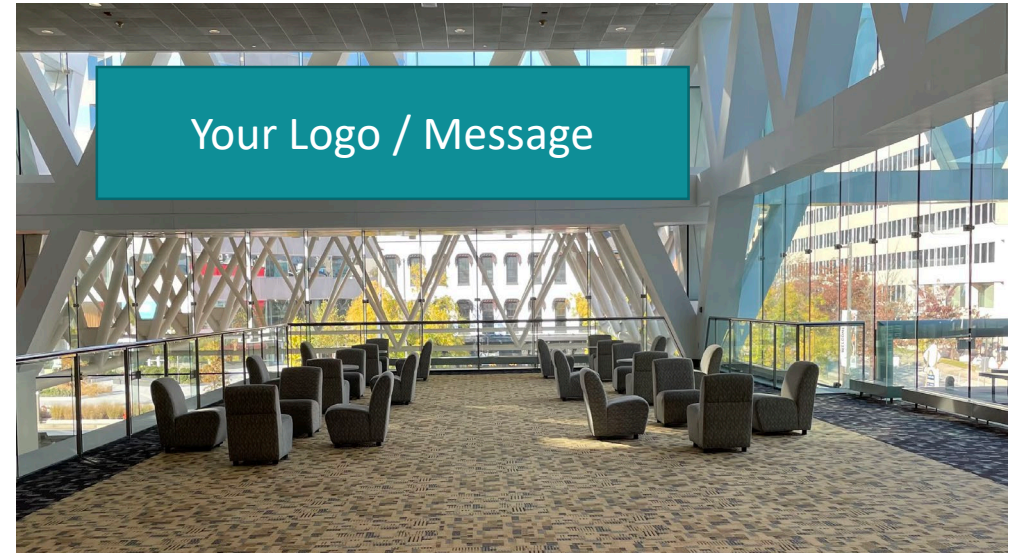

#aapmr22

**BALTIMORE, MD & VIRTUAL
OCTOBER 20-23, 2022**

Additional Signage Opportunities

- **4-Sided Kiosk**
 - Get your message seen in all directions!
Opportunity Cost: \$10,000
- **Light Box**
 - Light up your message!
Opportunity Cost: \$8,500
- **Meter Boards**
 - One or a series to tell a story!
Opportunity Cost: \$5,500
3 for \$12,500

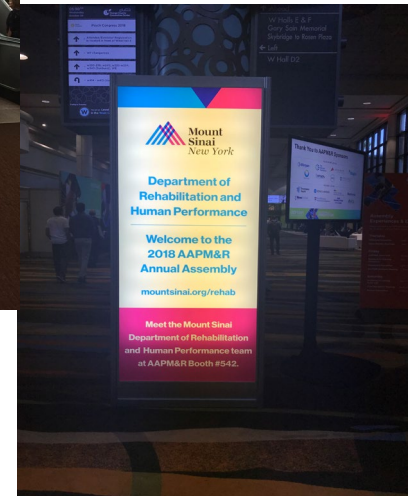

AAPM&R will place the signage in high traffic areas.

#aapmr22

**BALTIMORE, MD & VIRTUAL
OCTOBER 20-23, 2022**

Business Suites

Create a Private Exhibitor Suite

Order your Exhibitor Business Suite to create your *private* office right on the exhibit floor

Exhibitor Suite includes:

- Available Thursday through Sunday
- Space rental
- Fabric (Velcro ready) panels
- Sign (14"x22") with company name or company logo
- Carpet (13 oz.) and first night vacuuming
- Installation and dismantling labor
- Furniture Package Available
- **Order by September 30, 2022**

Prices starting at \$5,495 for a 10x10.

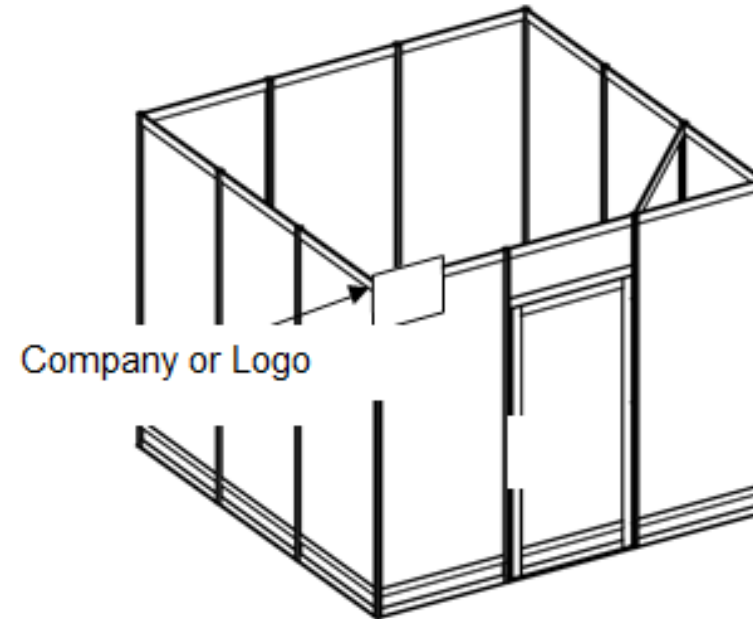

#aapmr22

**BALTIMORE, MD & VIRTUAL
OCTOBER 20-23, 2022**

Educate the Audience

On your product(s), science, services, and more

#aapmr22

**BALTIMORE, MD & VIRTUAL
OCTOBER 20-23, 2022**

Sponsored Session Opportunities

	Education Theater	Education Theater for Residents	Center Stage	Product Demos
Anticipated # of Attendees	175 to 200	75	25 to 30	12 to 18
AV	Stage, podium, 2 mics	Stage, podium, 2 mics	Stage, Monitor, Mic	Mic and Monitor as needed
Time	50 to 60 minutes	50 to 60 minutes	25 minutes	30 to 40 minutes
Cost	\$75,000	\$37,500	\$12,500	\$12,500

Educate Psychiatrists and Psychiatrists-in-Training in the format of your choice!

#aapmr22

**BALTIMORE, MD & VIRTUAL
OCTOBER 20-23, 2022**

Educate the Audience in a Large Theater

Education Theater

- Set for up to 200 attendees
- Held during unopposed hours on the exhibit floor
- Includes:
 - ✓ Basic AV: LCD projector, screen, podium with microphone and two wireless microphones
 - ✓ AV technician during the presentation
 - ✓ One person to scan badges plus the badge scanner
 - ✓ Access to theater room 60 minutes prior
 - ✓ Ability to set a poster up 60 minutes prior
 - ✓ Posting on the AAPM&R website, mobile app and on signage at the theater

Opportunity Cost: \$75,000



#aapmr22

**BALTIMORE, MD & VIRTUAL
OCTOBER 20-23, 2022**

Educate the Audience through Hands on / Product Demos

Learning Center – product demonstrations / hands on

- Held in a semi-private location within the learning center on the show floor
- 30-to-40-minute opportunity
- Includes:
 - Monitor
 - Set for up to 12 to 15
 - Recognition on signage at the learning center, in the mobile app and on the AAPM&R website

Opportunity Cost: \$12,500

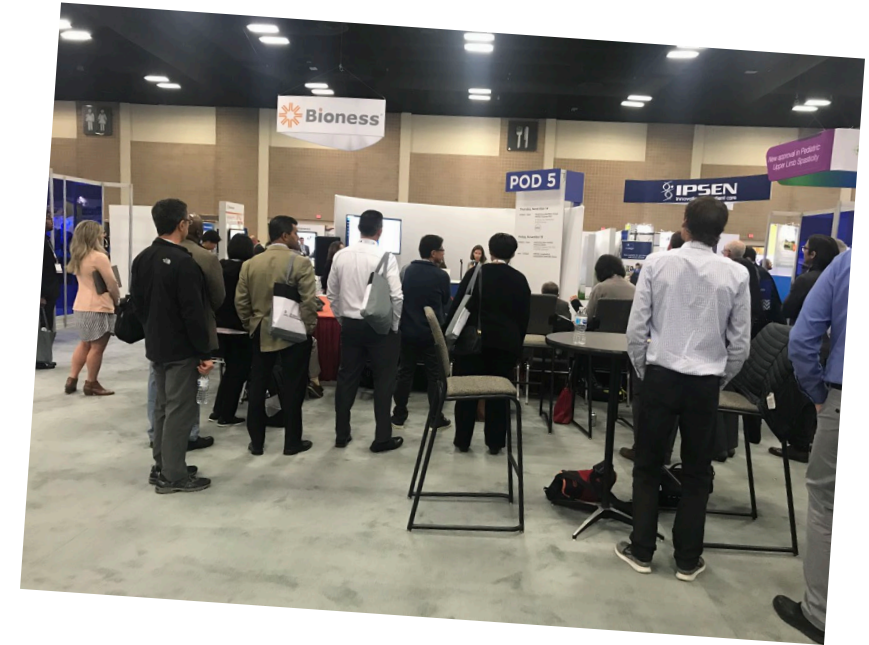

2019 hands-on

#aapmr22

**BALTIMORE, MD & VIRTUAL
OCTOBER 20-23, 2022**

Educate the Audience on the Center Stage

Learning Center Center Stage

- Held in theater location within the learning center on the show floor
- 20-minute opportunity (5-minute Q&A)
- Includes:
 - Monitor
 - Mic
 - Set for 25 to 30 attendees
 - Recognition on signage at the learning center, in the mobile app and on the AAPM&R website

Opportunity Cost: \$12,500



#aapmr22

**BALTIMORE, MD & VIRTUAL
OCTOBER 20-23, 2022**

Marketing Opportunity

- The marketing package provides ample opportunities to market your education to attendees. (This package is also available to drive traffic to your booth.)
- Includes:
 - ✓ Registration Bag Insert (\$10,000)
 - ✓ Pre-Show Mailing List (\$1,000)
 - ✓ Full Page Ad in Official Program (\$3500)
 - ✓ Hotel Door Drop (\$8,000)

Opportunity Cost: \$17,500

#aapmr22

**BALTIMORE, MD & VIRTUAL
OCTOBER 20-23, 2022**

Reach Residents

#aapmr22

**BALTIMORE, MD & VIRTUAL
OCTOBER 20-23, 2022**

Educate the Residents

Resident Education Theater

- Anticipated attendance of 75 Residents
- Held prior to the Job Fair on Wednesday
- Includes:
 - ✓ Basic AV: LCD projector, screen, podium with microphone and two wireless microphones
 - ✓ AV technician during the presentation
 - ✓ One person to scan badges plus the badge scanner
 - ✓ Access to theater room 60 minutes prior
 - ✓ Ability to set a poster up 60 minutes prior
 - ✓ Posting on the AAPM&R website, mobile app and on signage at the theater

Opportunity Cost: \$37,500



#aapmr22

**BALTIMORE, MD & VIRTUAL
OCTOBER 20-23, 2022**

PHiT Fest

Support three Physician-in-Training Events

- Resident Quiz Bowl
- Residents' Reception
- Resident Town Hall

Sponsorship includes:

- Recognition as a sponsor (with logo) on signage at each event, on AAPM&R website and the event Mobile App
- Reserved table at the Reception
- Ability to attend the Quiz Bowl and the Town Hall

Opportunity Cost: \$10,000

#aapmr22

**BALTIMORE, MD & VIRTUAL
OCTOBER 20-23, 2022**

Resident Boot Camp

- Taking place Thursday – Saturday, October 20-22
- Each session is 3 hours
- 2 sessions – topics to be determined
- Up to 50 attendees and 4 to 6 faculty
- There will be two boot camps in 2022
- **Sponsorship includes:**
 - Recognition as a sponsor (with logo) on promotional materials, at the session, on AAPM&R website and the event mobile app
 - Table-top exhibit near the session
 - Ability to provide AAPM&R with a handout for all attendees
 - Ability to observe the session (2 per supporter)

Session is not CME

Opportunity Cost: \$15,000

#AAPMR 2022 – Topics TBD

Examples of topics from past bootcamps

Resident Bootcamp 1: Ultrasound – Reviewing Essential Nerve Examination Techniques and Common Joint Injection Views (N)

Thursday, October 20: 2 pm-5 pm

Resident Bootcamp 2: Introduction to Upper Extremity Prosthetics / Lower Extremity Orthotics & Prosthetics (N)

Friday, October 21: 8 am-11 am

Resident Bootcamp 3: Spasticity Management - Reviewing Chemodenervation Techniques Including the Use of Ultrasound Guidance and Baclofen Pump Management (N)

Saturday, October 22: 2 pm-5 pm

#aapmr22

**BALTIMORE, MD & VIRTUAL
OCTOBER 20-23, 2022**

The Exhibit Pavilion

#aapmr22

**BALTIMORE, MD & VIRTUAL
OCTOBER 20-23, 2022**

The Assembly Pavilion

No booth yet? There is still time to reserve your booth!

Why?

Physiatrists visit the Pavilion, and you will have key interaction opportunities

Click here for [Exhibitor Application](#)

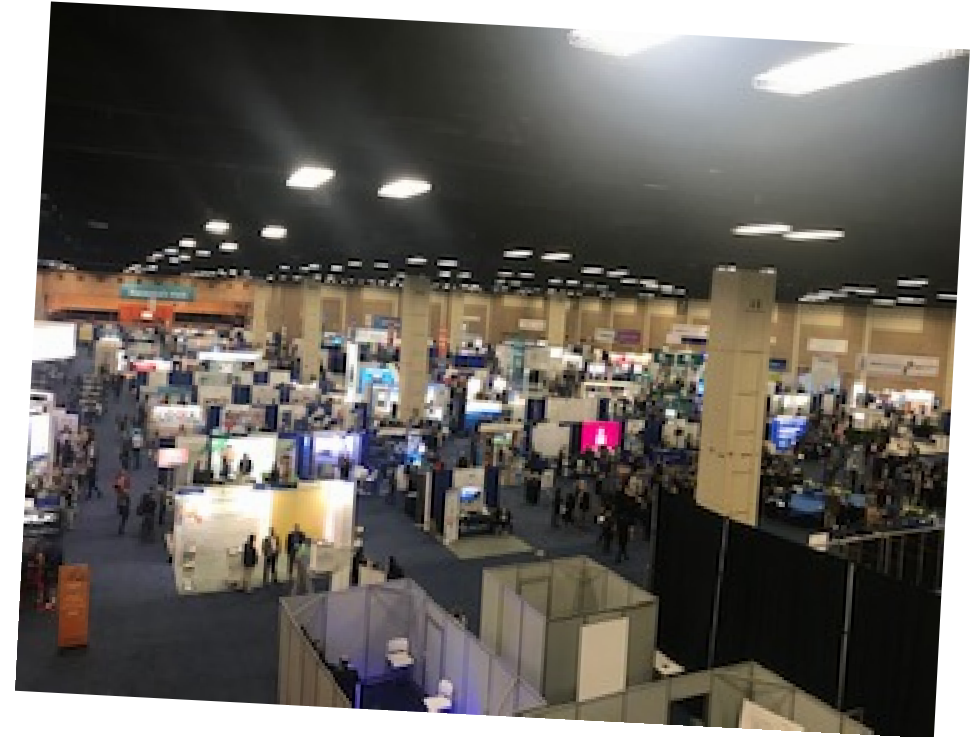

#aapmr22

**BALTIMORE, MD & VIRTUAL
OCTOBER 20-23, 2022**

Questions, Please Contact Us At:

Lisa Koch: Exhibits and Sponsorships

lkoch@conventusmedia.com

(617) 285-2320

Kathleen Noonan: Exhibits and Sponsorship

knoonan@conventusmedia.com

(781) 375-8584

**Sharon Popielewski: Business and Resource
Development/ Corporate Support**

Spopielewski@aapmr.org

(847) 737-6048

#aapmr22

**BALTIMORE, MD & VIRTUAL
OCTOBER 20-23, 2022**